

# CHAPTER 20

## INTRODUCTION TO INERTIAL NAVIGATION

### INTRODUCTION

#### 2000. Background

**Inertial navigation** is the process of measuring a craft's velocity, attitude, and displacement from a known start point through sensing the accelerations acting on it in known directions by means of devices that mechanize Newton's and Kepler's laws of motion (Section 1306), namely accelerometers and gyroscopes. Since these laws are expressed relative to inertial space (the fixed stars), the term "inertial" is applied to the process. **Inertial navigation systems (INS)** are used in a variety of military and civilian applications, including aircraft, spacecraft, rockets, and marine vessels. Development of the technology began in earnest in the U.S. following World War II. Since that time, inertial navigation system components have continuously grown both smaller and more accurate, while modern computers are able to quickly handle large numbers of computations.

Inertial navigation is described as "passive" because no energy is emitted to obtain information from an external source, and there is no need for continuous radio frequency reception from a fix source. Thus, inertial navigation is fundamentally different from other methods of navigation because it depends only on measurements made within the craft being navigated. However, additional navigation aids are often required to correct errors that develop in the system over time. These errors and navigation aids are discussed in Section 2015 through Section 2025.

Inertial navigation is often referred to as a sophisticated dead reckoning method because position is obtained by measuring displacements from a start point in accordance with the motion of the craft.

#### 2001. Basic Principle

The basic principle of inertial navigation is the measurement of the accelerations acting on a craft, and the double integration of these accelerations along known directions to obtain the displacement from the start point.

For example, if the indicated acceleration of the craft from rest is constant, velocity and distance traveled can be found from the equations:

$$v = at$$

and

$$s = 1/2 at^2$$

where  $a$  is the acceleration,  $v$  is the velocity,  $s$  is the distance, and  $t$  is the time. But these equations assume that acceleration is constant and cannot be used otherwise. For varying accelerations the following equations (using calculus notation) are needed:

$$v = \int a dt$$

$$s = \int v dt$$

where  $\int$  denotes an integral (analogous to a summation) and  $dt$  denotes a very small increment of time.

### SENSORS

#### 2002. Sensors

Inertial sensors used in the mechanization of Newton's laws of motion, hereafter called the inertial navigator or inertial navigation system (INS), are gyroscopes and accelerometers. The gyroscopes sense angular orientation or motions of the vessel. The accelerometers sense the vessel's linear accelerations, which are changes in linear velocity. The inertial sensors are subject to all motions of the vessel in inertial space, including those that do not change the vessel's position or orientation on the earth, such as the earth's rotation. Thus, it is necessary to apply certain corrections to the inertial motions (Section 2004) sensed in

order to obtain just the motions of the inertial navigator with respect to the earth.

#### 2003. Gyroscopes

At the very basic level, a gyroscope (or "gyro") is a device that can be used to detect and measure angular rotation. It is a key component of inertial navigators because it provides the information required to accurately determine the orientation of the inertial sensors (gyroscopes and accelerometers) within inertial space. Without these devices, the navigation computer would be unable to correctly attribute acceleration forces to the  $x$ ,  $y$ , and  $z$  axes.

This would make accurate determination of ship velocity and position impossible.

One common configuration of gyros in an INS is that each gyroscope only senses rotation around a single axis. With three gyros mounted such that their input axes are mutually perpendicular, three-dimensional attitude control of the platform is obtained.

The classical gyroscope is a spinning mass gyroscope. Spinning mass gyros are still in use in specialty and high-accuracy applications; however, in many INSs, the spinning mass gyroscope has been replaced in recent decades with gyroscopes more suitable for a strapdown implementation (Section 2009). The predominant gyroscopes used in inertial navigators today fall into the class of gyroscopes using the principle of light (optical gyroscopes) and vibrating structure gyroscopes. Rather than directly measuring the change in angular orientation, these types of gyros measure the angular rate, from which orientation can be computed. The following discussions of these three classes of gyros are written to meet the needs of an introductory treatment of inertial navigation.

#### 2004. Spinning Mass Gyroscopes

A simple spinning mass gyro consists of a rotating wheel or ball, which may be supported by a series of gimbals to allow for three degrees of freedom of movement. The principle of conservation of angular momentum states that a system will maintain its angular momentum as long as no external forces are applied to it. Thus, the mass of the gyroscope must maintain a constant angular momentum about its spin axis if no external forces are applied. Both the amplitude and direction of the angular momentum must be conserved. The spin axis, therefore, tends to maintain the same direction in inertial space. This property is called gyroscopic inertia or rigidity in space. This is the same property that keeps a children's spinning top or a moving bicycle upright.

If a rotational or couple force is applied to the spinning mass through the gyroscope's supports, an additional angular momentum is introduced. The gyroscope's orientation will change to include this along with its original angular momentum about the spin axis. This property of the gyroscope is called precession.

Precession causes the gyroscope to tend to align its spin axis with the axis of the applied torque (Figure 2004). If the axis of applied torque is designated as the input axis, then the precession of the gyroscope can be determined by rotating the spin axis into the input axis through the smaller angle. Using this nomenclature the axis of precession is often called the output axis. By measuring the displacement of the spinning mass about this output axis, the magnitude of the torque acting about the input axis on the spinning mass can be inferred. In a gimballed INS (Section 2009), a control system works to counter-rotate/counter-torque the platform or table to which the gyro is attached. The counter-

rotation returns the gyro to its original (or correct) orientation and “nulls” out the gyro's report of rotation. This type of control system can be used to stabilize a platform at a given orientation regardless of ship's motion. In a strap-down INS, the measurement of precession is used to mathematically determine the platform's new orientation. See Figure 2004.

#### 2005. Optical Gyroscopes

Optical gyros such as **ring laser gyros (RLG)** and **fiber optic gyros (FOG)** make use of the **Sagnac principle** to measure rate of angular rotation. To visualize how this principle is employed to measure rotation, one can imagine two light beams, one traveling clockwise (CW) and the other traveling counterclockwise (CCW) about a circular optical path, as shown in Figure 2005a. Both light beams leave from the same origin, point A, at the same time. If the circular path is then rotated, for example in the CCW direction so that the origin is now at point B, then the light beams traveling in the CW direction will now have a shorter optical path to return to the light source origin, while the CCW beam will now have a longer optical path. Because the speed of light is constant, the two light beams will continue to travel at the same speed despite this rotation, and the CW beam will arrive back at the origin before the CCW beam will. The amount of rotation can be calculated by measuring the difference in arrival time between the two light beams.

In practice, the difference in arrival time between the two beams is not measured directly. Rather, when the path is rotated, the two beams of light undergo a wavelength shift, meaning that the distance between points of maximum amplitude of the waves either shortens or lengthens. In the example above, the CCW beam would have a longer wavelength, and the CW beam would have a shorter wavelength. When the two beams recombine at the origin, the maximum and minimum points on the two waves are no longer aligned with each other. The misalignment creates an interference pattern from which the difference in the two wavelengths can be obtained. This calculation is used to determine the angle of rotation.

Optical gyros do not resist changes to their orientation the way spinning mass gyros do. However, they are still considered gyros due to their ability to sense rotation.

In an RLG, the circular path is replaced with a polygon path (often triangular), which is constructed using mirrors at each corner of the polygon (Figure 2005b). The pathway consists of a sealed channel which is filled with a mixture of gases that emit light when ionized. High voltage applied to electrodes in the channel ionizes the gas and causes lasing action. The lasing generates a standing light wave which is analogous to two counter-propagated light beams, and the change in wavelengths of the beams determines the rotation rate, as described above.

In a FOG, the laser is separate from the rotating channel. Two beams are injected in opposite directions into a

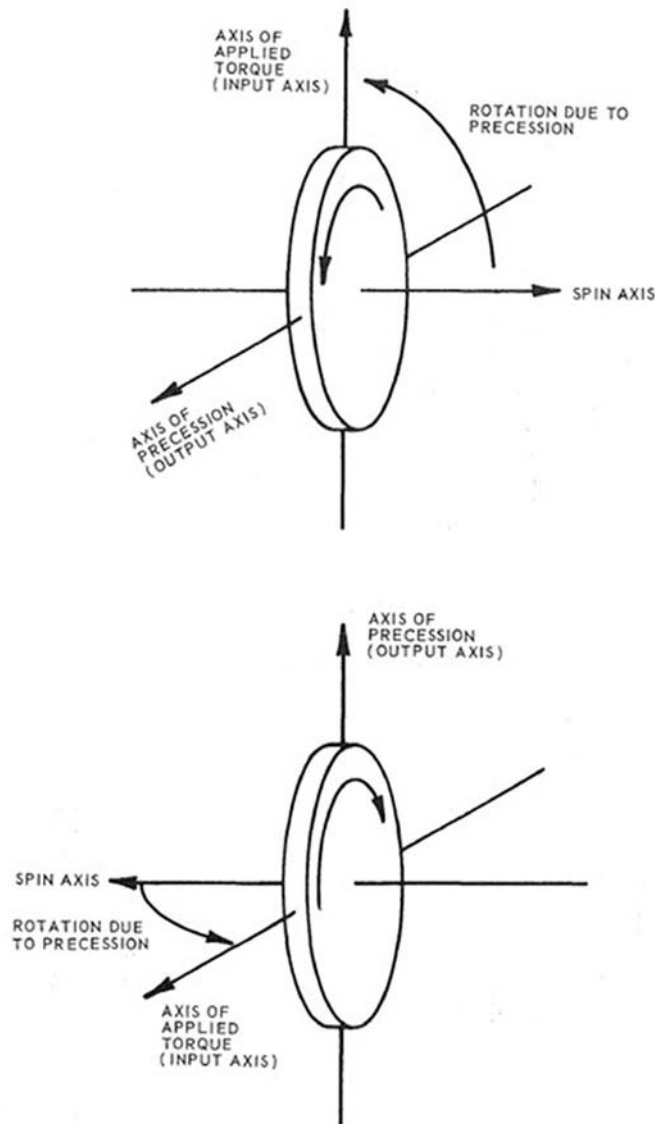

Figure 2004. Precession of a gyroscope.

coiled optical fiber (Figure 2005c), which may be more than a mile in total length. Again, the difference in wavelengths determines the rotation rate.

### 2006. Vibrating Structure Gyroscopes

The underlying principle of vibrating structure gyros is that when a vibrating object is rotated, the vibration will tend to continue in the same plane, rather than rotating with the object. In these gyros, the mass is generally driven to resonance (the mass's natural vibrating frequency, at which it will vibrate with maximum amplitude) by electrostatic forces. When the object is rotated, the vibration patterns begin to precess around the axis of rotation, similar to the precession seen in spinning mass gyros (Section 2004). Several variations of vibrating structure gyroscopes exist; a few are described here.

A hemispherical resonator gyroscope (“wine-glass resonator”) is based on the rotation-sensing properties of a ringing wine glass. This gyro consists of a thin hemisphere, commonly made of quartz glass, anchored by a thin stem. Electrodes surrounding the shell provide the forces that drive the shell to resonance. This type of gyro is highly accurate, but requires precision manufacturing and sophisticated electronics to drive and sense the standing wave on the shell.

Tuning fork gyroscopes use a pair of test masses driven to resonate with equal amplitude but in opposite directions. Rotation can be determined by measuring their displacement from the plane of oscillation.

In vibrating wheel gyroscopes, a disc vibrates around its center axis. Rotation around either of the other two axes (those in the same plane as the disc) causes the disc to tilt. This tilt can be measured by sensors under the disc.

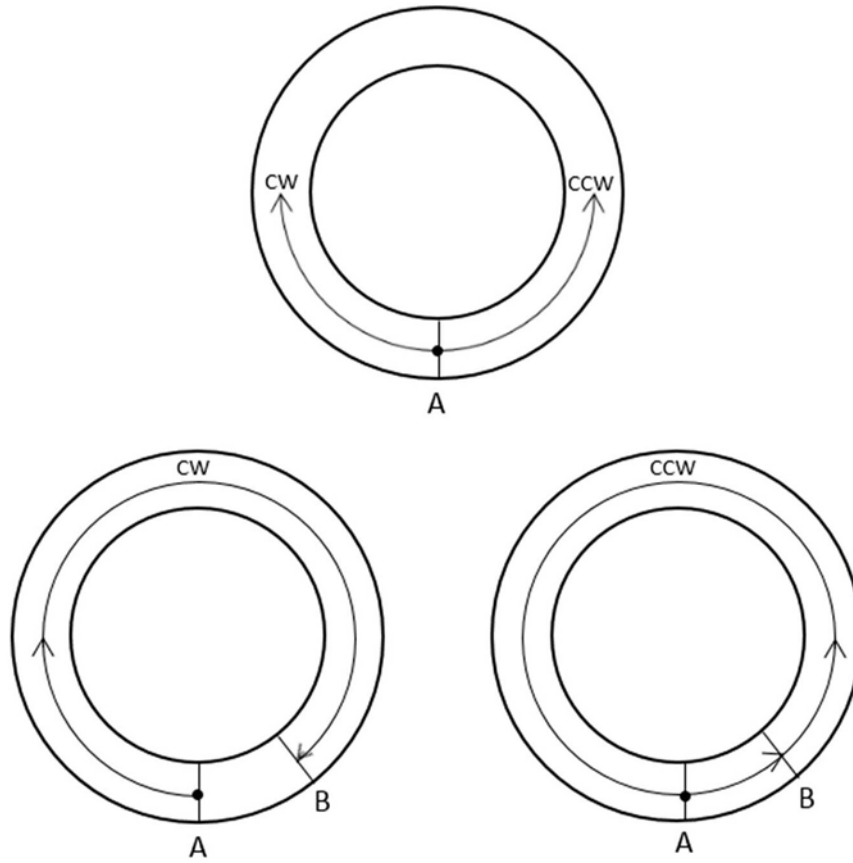

Figure 2005a. Illustration of the Sagnac principle in optical gyros.

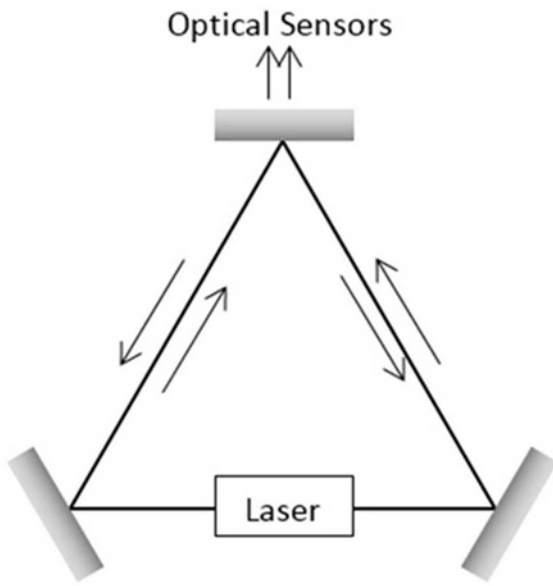

Figure 2005b. Ring Laser Gyro.

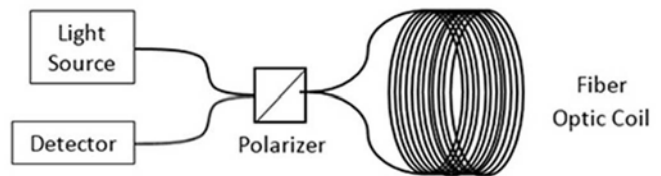

Figure 2005c. Fiber Optic Gyro.

**Microelectromechanical systems (MEMS)** employ vibrating structure gyros. These are small, relatively inexpensive gyros packaged as integrated circuits. Current technology has allowed these types of gyros to become commonplace, integrated into systems such as automobiles, smartphones, and video game controllers. However, their use in navigation is limited to applications where GPS is nearly continuously available, due to the long-term error growth of the present technology.

### 2007. Accelerometers

Velocity is the linear rate of change of position. If the velocity is known it can be integrated with respect to time to determine the change in position. However, no external forces are required for movement at a constant velocity; therefore, constant velocity cannot be sensed or measured with an inertial device.

A body at rest will remain at rest unless acted upon by an external force, and a body in motion will retain the motion unless acted upon by an external force. By measuring forces acting on a test mass, *changes* in velocity can be detected. This rate of change in velocity, called acceleration, is what accelerometers measure. Three accelerometers are mounted in an INS such that they sense accelerations along three mutually perpendicular axes.

In its simplest form, the accelerometer consists of a test mass, as shown in Figure 2007, constrained to measure accelerations in a particular direction (the sensitive axis) with a scale, or other appropriate device, to indicate its output. If the frame is accelerated to the right (Figure 2007, view B) the test mass lags behind since the acceleration is applied to the frame, not the test mass. The test mass displaces enough for

the constraining springs to apply a force proportional to the acceleration. The test mass then moves with the case maintaining its constant displacement. When the acceleration is removed from the frame, the constraining springs cause the test mass to move (with respect to the case) back to the neutral position. Thus, a body at rest or a body at constant velocity (zero acceleration) causes no displacement, providing the accelerometer is held horizontal. If the accelerometer is tilted or placed on end, the force of gravity causes the mass to move in the same way as does an actual acceleration, even though the frame is at rest.

This basic accelerometer demonstrates the principle of operation of inertial accelerometers. It must be kept in mind that these inertial accelerometers are sensitive to more than just the accelerations with respect to the earth. Since they are sensitive to accelerations in space, their output includes other inertial accelerations which are not due to travel over the earth's surface. A compensation must be made for these inertial accelerations so that the quantity left is the acceleration with respect to the earth. What these inertial accelerations are and how compensations are made is discussed in Section 2014.

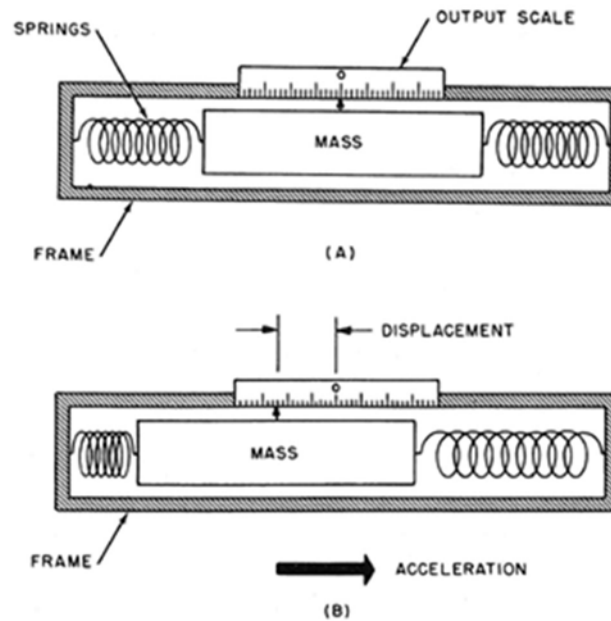

Figure 2007. Basic accelerometer.

## INERTIAL NAVIGATION SYSTEM MECHANIZATIONS

### 2008. Inertial Navigation System Mechanizations

An INS may be mechanized as either a gimballed system or a strapdown system. In both mechanizations, the accelerometers function to sense the linear accelerations of the craft, from which linear velocity is computed, and the gyros

function to sense the angular motions of the craft. However, in a gimballed system, the gyros respond to the sensed motions by rotating the platform (with the help of gimbal torquer motors, as necessary) so that a constant frame of reference is maintained and the outputs of the gyros remain at zero. Thus, the craft's velocity, attitude, and position can be

directly computed with respect to the constant reference frame. In a strapdown system, the gyros are fixed to the craft and sense its full rotational rate as it maneuvers. The output of the gyros is used by the navigation computer to relate the motions sensed by the accelerometers to the desired reference frame.

Both inertial navigator mechanizations are described below. Although most systems nowadays are strapdown, the discussions throughout this chapter assume a stable platform (gimbaled) implementation, as it is easier to visualize inertial navigation principles using a gimbaled model. These discussions are mathematically equivalent to a strapdown model. In addition, no matter the mechanization, all inertial navigators operate on the same principles and are subject to the same fundamental types of errors (Sections 2015 - 2021).

### 2009. Gimbaled INS

In a gimbaled INS, the gimbals, gyroscopes, and accelerometers together with associated electronics and gimbal torque motors form a stable platform. The function of this stable platform is to establish and maintain a reference system in which the measurements necessary to produce the navigator outputs are taken. The stable platform may be aligned to any chosen reference system, but two that have been historically used are the inertial reference system and the local vertical reference system.

A platform aligned to an inertial reference system (i.e., the fixed stars) is called a space-stable INS. In a space-stable INS, the platform is stabilized to maintain accelerometer alignment in a constant direction relative to distant space, regardless of the platform's orientation with respect to the earth. The inertial reference system complements the natural behavior of spinning mass gyros, although any type of gyro may be utilized in any reference system.

A platform in local vertical alignment is oriented such that one accelerometer is aligned with the vertical gravity vector. The other two accelerometers are generally aligned in the north and east directions. Torqueing motors on the gimbals are used to maintain this alignment. A variation of the local-vertical system is the wander-azimuth mechanization, in which the horizontal accelerometers are not slaved to the north and east directions, but are allowed to “wander” around the vertical axis. This mechanization is especially useful near the poles, where even small vessel motions would require frequent torqueing of the INS due to the meridian convergence. An advantage to either form of local vertical alignment is that the horizontal accelerometers are isolated from measuring gravity.

Since the craft in which the stable platform is mounted operates in three dimensional space, it has three degrees of freedom with respect to the earth. In order to maintain a reference fixed to the earth, the stable platform must have

three degrees of freedom with respect to the craft. The stable platform contains at least three gimbals, one for each degree of freedom necessary for the stable platform. (Extra gimbals may be used to improve mechanical performance). Each gimbal has rotational freedom about one axis with respect to its supporting element. Depending on the platform mechanization, the gimbal may have a torqueing motor that allows it to be driven with respect to its support about the gimbal axis.

### 2010. Strapdown INS

In a strapdown INS, the accelerometers and gyroscopes are connected directly to the frame of the vehicle—that is, they are not isolated from the ship's movement by a series of gimbals. Instead, the sensors measure accelerations directly in the craft's reference frame, and the navigation computer analytically “rotates” these measurements into the desired navigation reference frame based on the output of the gyros. From this point, the accelerometer measurements can be integrated into velocity and position in the desired frame. In general, a strapdown INS trades the mechanical complexity of a gimbaled system for the computational complexity required to track all the craft's motions analytically.

Unlike gimbaled gyros, which only sense small rotations as they continuously re-orient the stable platform, strapdown gyros are exposed to the full rotational rate of the craft. Thus, gyros used in strapdown systems must be able to maintain accuracy over-essentially, “keep up with”—those rotational rates. While typical rotational rates of a maritime craft are unlikely to strain a gyro's performance, crafts such as military aircraft require robust sensors to handle their high rotational rates. Strapdown inertial navigators that use optical gyros are especially useful for such vehicles, as well as for applications where size, weight, and cost constraints are important considerations

### 2011. Hybrid (Quasi-Strapdown) INS

In a quasi-strapdown INS, the accelerometers and gyroscopes are mounted on a stable platform supported by one or more sets of gimbals, similar to a true gimbaled INS (Section 2009). The difference is that the stable platform is not rotated to maintain local level continuously; rather, the stable platform is rotated through various angles, typically 90 degrees or 180 degrees, to a new position every few minutes to reverse and manage long-term error growth. Quasi-strapdown INSs that use optical gyros share common traits with both the gimbaled and strapdown INS. Typically, they are chosen for increased long-term navigation accuracy (longer time needed between external fixes) but at a lower cost, size and weight of a fully gimbaled INS. The current US Navy AN/WSN-7 is an example of this type of INS.

## MOTIONS AFFECTING INERTIAL NAVIGATION SENSORS

### 2012. Motions Affecting Inertial Navigation Sensors

The INS sensors will detect any motion relative to inertial space, including motions that do not describe position, velocity, or orientation with respect to the earth. This means that any motion or force which might disturb the reference system must be accounted for and its effect must be eliminated. This would include motions in inertial space as well as motions of the craft in which the navigator is mounted.

The motions affecting the inertial sensors may be divided into two categories: rotations and accelerations. The rotations are:

1. Craft's roll, pitch, and yaw
2. Earth's rotation (earth rate),
3. Changes in latitude and longitude.
4. Platform indexing, where applicable

The accelerations of concern are:

1. Craft's acceleration with respect to the earth in three linear directions,
2. Gravity,
3. Coriolis acceleration.

These motion-based impacts on the INS are a function of the physics of motion on a rotating and spinning ellipsoid, are predicable, and are generally accounted for within the processing of the equations of motion. Other factors that can influence the sensors outputs, including environmental, electrical, and magnetic influences, must be managed within the design and implementation, and are not always predictable. Controlling these factors is discussed in Sections 2023 - 2025.

There are also some inertial motions whose effects are negligible; that is, their effects are below the sensitivity level of the sensors. These motions are precession and nutation (Sections 1317, 1319) and the acceleration of the earth in its orbit in accordance with Kepler's second law (Section 1306).

Since the inertial navigator deals with the earth-referenced values of velocity, attitude, and position, and since the gyroscopes sense direction with respect to inertial space, it is necessary that the gyroscopes be controlled to maintain a reference with respect to the earth. In the discussion of the inertial navigator which follows, unless otherwise noted, the earth reference used is the local vertical and an orientation with respect to true north. However, the same principles apply, either physically or computationally, to all INS mechanizations.

### 2013. Rotations

1. Roll, pitch, and yaw describe the orientation of a vessel in its local reference frame, thus, are desired measurements of the INS and do not require additional compensations.

For a gimballed platform, if the supporting craft should undergo any base motion (roll, pitch, or yaw) about a gimbal axis, the platform would ideally remain fixed in inertial space. However, some friction in the gimbal axis will always exist, so some small portion of the motion of the supporting craft will be transmitted to the platform. The gyroscope would sense this motion instantaneously, and its output would excite the gimbal torquer motor which in turn would drive the gimbal with respect to the craft about the gimbal axis, counteracting the motion that had been transmitted to the platform. If the rate of platform disturbance increases or decreases, the gyroscope output signal increases or decreases to keep the gimbals-and thus, the accelerometers-in the same position relative to the earth

For a strapdown system, gimbals and torquer motors are not used. The INS computer interprets the output of the gyroscopes and uses this information to mathematically orient the platform's accelerometers.

2. The rotation of the earth causes the local vertical, north and east directions for a given position to change their directions in inertial space. These changes are not obvious to anyone on the earth because they maintain the same orientation with respect to the earth. Thus, the gyroscopes will sense motion due to the earth's rotation even when the vehicle is stationary on the earth. To compensate, an earth rate torquing signal is applied so that the inertial navigator rotates about the earth's spin axis at the same rate that the earth does. As a result, the inertial navigator maintains the desired orientation with respect to the earth as the earth rotates in inertial space, and the apparent motion of the vessel is canceled. For strapdown systems, the earth rate correction is made mathematically within the INS computer rather than with gimbals

3. Changes in latitude and longitude are desired outputs of the INS, and are measured in the same way that roll, pitch, and yaw motion are measured. However, an additional compensation is needed due to the fact that the vessel is navigating on or near a spherical earth, rather than a flat plane: The change in position of the inertial navigator on the earth's surface causes the local vertical to change direction in space. This is due to the fact that in going from one position to another the inertial navigator is changing from one local vertical to another. This is demonstrated in Figure 2013a. As the inertial navigator travels over the earth's curved surface from position 1 to position 2, the "correct" orientation is shown by the solid line figure at position 2. The broken line figure represents the inertial navigator after the change in position without compensation for the change in the local vertical.

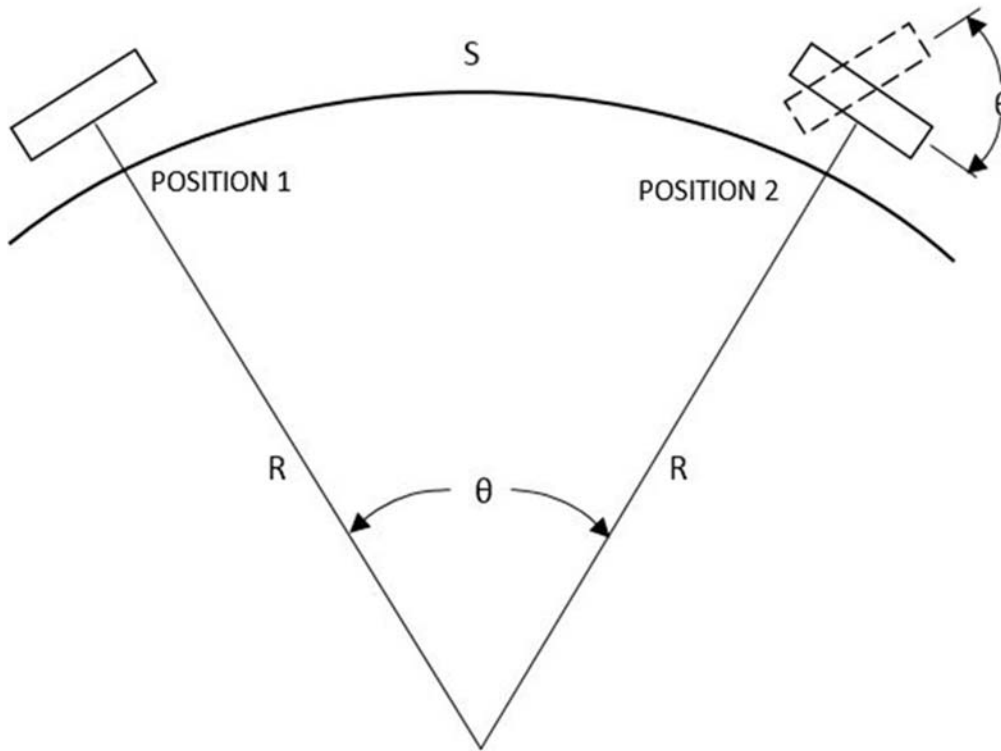

Figure 2013a. Change in local vertical with movement over earth's surface.

As shown in Figure 2013a, the total angular change in the local vertical in moving from position 1 to position 2 is represented by  $\theta$ . The value of  $\theta$ , expressed in radians, is a function of the distance traveled,  $S$ , and the radius of the earth,  $R$ . Stated mathematically, this is:

$$\theta = \pm \frac{S}{R}$$

(The  $\pm$  sign is determined by the direction of travel in the right-handed north-east-down coordinate system: Movement in the positive east direction causes a positive rotation around the north axis, while movement in the positive north direction causes a negative rotation around the east axis. See Figure 2013b.

The quantity of interest in maintaining the correct orientation to the local vertical due to change in position is the rate of change of  $\theta$  with respect to time. Assuming  $R$  to be constant, the angular rate  $\omega$  is given by:

$$\omega = \frac{d\theta}{dt} = \pm \frac{1}{R} \frac{dS}{dt}$$

Since the time rate of change of distance,  $S$ , is velocity,  $V$ ,

$$\omega = \pm \frac{V}{R}$$

Thus, the appropriate gyroscopes must be torqued at this rate, or the compensation applied through the computer for strapdown systems, so that the vertical indication of the inertial

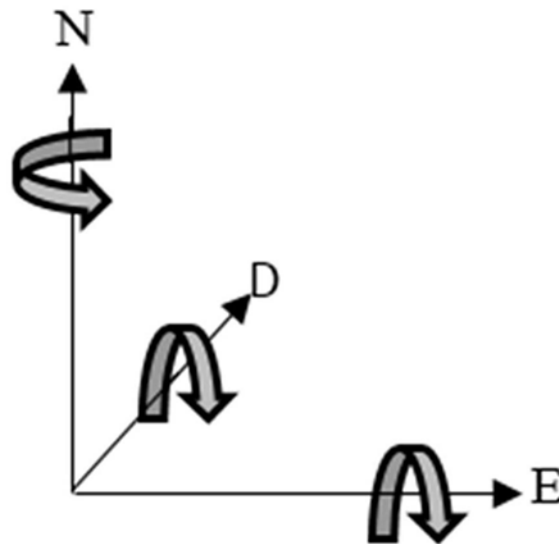

Figure 2013b. Right-handed north-east-down coordinate system.



navigator will remain correct as the craft moves over the curved surface of the earth. When the gyroscopes receive a properly calibrated signal to compensate for the change in the local vertical due to movement over the earth, the system is said to be *Schuler tuned*.

**Schuler compensations** are required in both horizontal directions in order to maintain the correct orientation of the vertical. In the local vertical INS example, the north Schuler compensation includes the north gyroscope and the east accelerometer. The east Schuler compensation includes the east gyroscope and the north accelerometer.

The Schuler compensation corrects the INS platform tilt caused by its motion over the surface of the earth, thus keeping the platform correctly aligned to the local vertical. However, if a platform tilt arises that is not due to motion over the earth, or if the calculated angular rate and the actual angular rate are not identical, the result is a **Schuler oscillation** (Section 2018).

4. Some INS are mechanized to use one or more gimbals to change the physical orientation of the platform sensors at specific intervals. This is done to reduce long-term error growth due to misalignment of the sensors. When the platform is flipped (or “indexed”), sensor misalignments become oriented in a different direction, causing the direction of error growth to change. The gyros, naturally, sense these movements as actual ship rotations. However, the periodicity of these movements is part of the system design, and the INS computer mathematically cancels these sensed rotations from its outputs of position, velocity, and attitude, for these sensed rotations.

## 2014. Accelerations

1. The craft's accelerations with respect to the earth are desired outputs of the INS and are measured by the accelerometers. For stable platforms, the accelerometers measure changes in velocity in the three constant, desired directions. For strapdown systems, the INS computer interprets the output of the gyros to assign directions to the sensed accelerations. By integration of these measurements over an accurate measure of time (Chapter 16), velocity and position are obtained.

Accelerometers may also sense roll, pitch, and yaw motion if the INS is not centered on the axis of rotation of the vessel. For example, one can imagine an INS located at either the port or starboard hull of a ship, rather than at the centerline. As the ship rolls around the centerline, the INS will be physically displaced in both the vertical direction and at least one horizontal direction. The accelerometers will sense this motion and integrate into a velocity and ultimately a change in position. However, the oscillatory nature of base motions means that this position change will be canceled when the vessel then rolls in the opposite direction. Thus, detection of base motions will not lead the INS to falsely compute long-term changes in position.

2. If the accelerometer is tilted, its output will be

affected by **gravity**. The output which would be produced would not be due to any acceleration of the inertial navigator with respect to the earth; thus, a compensation must be made. The simplest solution for elimination of the effect of gravity is to place the accelerometer so that its sensitive axis is perpendicular to gravity. Since all accelerations which result in a change in position are perpendicular to the local vertical, this orientation allows the accelerometer to measure these accelerations without being affected by gravity. Two accelerometers, then, are placed perpendicular to the local vertical and perpendicular to each other so that together they can measure any acceleration which will result in a change of position on the earth's surface. A third accelerometer is necessary to measure any accelerations of the navigator along the local vertical. (This is the orientation of accelerometers used in the local vertical mechanization of the INS). The accelerometer that measures motion in the vertical direction also senses the total magnitude of gravity acceleration. The INS computer compensates by removing the known acceleration of gravity from the vertical channel before computing velocity. For an INS that is not oriented in the local vertical reference frame, the INS computer subtracts gravity from all accelerometers as necessary.

The geometric figure that describes the earth's gravitational equipotential is called the geoid. This is the irregular surface to which the oceans would conform over the entire earth if free to move through landmasses and adjust to the combined effect of the earth's mass attraction and the centrifugal force of the earth's rotation. The geoid has a special property that, at every point on the geoid, the direction of gravity is given by a plumb line at that point. However, inertial navigation systems are mechanized in terms of a reference ellipsoid, which approximates the geoid but is not an exact match. Relative to the ellipsoid, the direction of gravity is not always a plumb line. The angle between the normal to the geoid and the normal to the reference ellipsoid is called the **vertical deflection** (or deflection of the vertical). If the vertical deflection is not accurately modeled within the INS computer, errors will be induced in the INS output due to the accelerometers interpreting components of gravity as accelerations over the earth. Thus, it is important that the gravity be well mapped to ensure accurate INS output.

The reference ellipsoid currently used by GPS systems and by United States navigation charts is the **World Geodetic System of 1984** (WGS 84). Further information on WGS 84 and vertical deflection can be found in Chapter 2 - Geodesy.

3. The **Coriolis acceleration** is not a true acceleration, but an apparent effect observed in a rotating reference frame as Newton's laws of motions play out in inertial space. When a vessel moves over a rotating surface perpendicular to the axis of rotation, it must provide a force to overcome inertia and continue moving at a constant velocity relative its local, rotating frame. The inertial

accelerometers sense this force and interpret it as a change in speed. This INS computer must cancel this effect to obtain an accurate measure of the speed relative to the rotating frame. A merry-go-round can be used to illustrate the Coriolis acceleration phenomenon.

If as shown in Figure 2014 a ticket-taker starts from the center of a merry-go-round with a velocity,  $v$ , toward horse A, he will reach the horse at some finite time  $t$  later. With respect to the merry-go-round he traveled at a constant velocity and therefore did not accelerate. However, when using the ground below the merry-go-round as the reference in which to make the measurements of his motion, it can be seen that in the time it takes for the man to get to the horse, the horse has moved to position A'. This is due to the rotation,  $\omega$ , of the merry-go-round. The path of the man with respect to the ground is shown as the solid curve even though his velocity with respect to the merry-go-round is directed radially at all times as shown by the two representative vectors along the path.

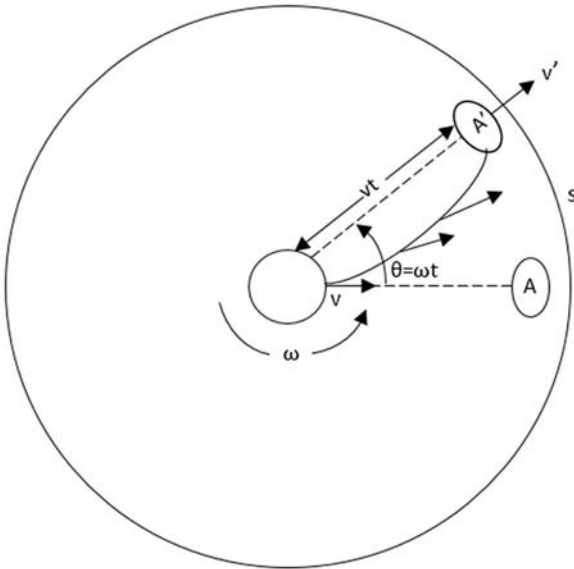

Figure 2014. Motion on a merry-go-round.

Although the ticket-taker is walking at a constant velocity, he finds that as the ride rotates counter-clockwise, he must exert extra force to his left in order to continue on his straight-line path. Otherwise, his walking tends to drift to the right due to inertia. This is an example of the Coriolis effect: a sensor on the ticket-taker's body would sense the exerted force to the left even though in his own reference frame he did not change either speed or direction.

While traveling from the center to the horse, the man was moved (with respect to the ground) counterclockwise, a distance  $S$ . This distance, written in terms of the acceleration which produced it, is:

$$S = 1/2 at^2$$

The distance may also be expressed in terms of the angle  $\theta$  (which equals the angular rate,  $\omega$ , of the merry-go-round multiplied by the time,  $t$ ) and the radius (which equals the velocity,  $v$ , of the man with respect to the merry-go-round multiplied by the time,  $t$ , involved). This expression is:

$$S = \theta vt = \omega t vt = \omega vt^2$$

By equating these two expressions and solving for  $a$ ,

$$1/2 at^2 = \omega vt^2$$

The principle of conservation of angular momentum states that a mass in motion will maintain its angular momentum if no external forces are applied. The formula for angular momentum is given by:

$$\text{angular momentum} = r mv$$

On the earth, as a body in motion travels northerly in the Northern Hemisphere, the radius  $r$  of rotation decreases with latitude. In order for the angular momentum of the body to be maintained in inertial space, its linear velocity  $v$  must increase in the direction of rotation (eastward for a counterclockwise-rotating earth) as  $r$  decreases. As the body moves northward and its easterly velocity increases, it gets deflected to the right relative to the earth's coordinate system. In inertial space, however, no acceleration occurred; thus, the accelerometers did not sense the deflection. Conversely, the body must exert a force to the left (westward) in order to continue on a straight northward path at a constant velocity relative to the earth. In this case, the accelerometers sense the westward force even though no acceleration took place in the earth reference frame.

If a body were to move southward in the Northern Hemisphere, the radius of rotation would increase, necessitating a decrease in velocity in the direction of rotation in order to change angular momentum. The body would again be deflected to the right-westward this time-as its linear velocity slowed relative to the earth reference frame. In the Southern Hemisphere, bodies traveling in either direction would be deflected to the left and have to compensate with an acceleration to the right.

The change in the earth's radius of rotation is proportional to the convergence of the meridians, or the sine of the latitude. Thus, for a body traveling over the earth, the acceleration is given by:

$$a = 2\omega v \sin(L)$$

where  $\omega$  is the earth's rotational rate,  $v$  is the north-south velocity of the moving craft, and  $L$  is the latitude. This apparent effect was first discovered by Gaspard Gustave de Coriolis, for whom it was named, shortly before the middle of the nineteenth century.

## INERTIAL NAVIGATION SYSTEM ERRORS

### 2015. Inertial Navigation System Errors

Every INS, regardless of its mechanization, provides an output that is corrupted by various errors. In many cases, the observed errors in INS output of position, velocity, and attitude are caused by errors in the accelerometer and gyro output or alignment. Other sources of errors in INS output include errors associated with the physics of sensing motion on a rotating planet, unmodeled geodetic or geophysical parameters like gravity, processing errors, manufacturing variances in the hardware and sensors, aging effects of components, timing latency errors (differences in time that INS and other sensors measure the same motion), and environmental effects. For mariners, the parameters being measured (vessel accelerations) are so small that even manufacturing variances or environmental changes are of possible impact. In particular, optical gyros are so sensitive that changes in temperature and pressure need to be accounted for and managed.

In general, INS are designed for specific applications and requirements (including performance, cost, size, weight and power) and all engineering designs require some tradeoffs to meet the specifications. The INS needed by an aircraft under high-G flight conditions and relatively short duration flights (hours) is different from a submarine transiting at relatively slower speeds, with few fix opportunities, and supporting long duration missions (weeks to months).

For the mariner, there are four errors in the horizontal channels that are observable by the navigator in real time and can be managed with proper operation, grooming and maintenance: The 84.4-minute Schuler oscillation, the 24-hour earth loop oscillation, position offsets, and longitude ramps. Modern INSs are “tuned systems” designed to reduce known errors at specified natural frequencies; thus, any noise introduced will often result in a tuned error response, such as the Schuler error.

The following sections describe the major INS sensor errors as well as the four observable errors in INS output. Also presented is an additional coordinate system, which is useful for visualization of the causes of some of the observable errors. Techniques to control these errors are discussed in Sections 2023 - 2025.

### 2016. Sensor Errors

INS sensor errors are the predominant cause of the four observable errors in INS output. Typical errors present in most INS sensors are described below.

**Sensor biases:** Accelerometer and gyroscope biases are the average outputs when the sensors are stationary and sitting still. Since accelerometer outputs are integrated to velocity and a gyroscope is integrated to find platform ori-

entation angle, uncorrected constant sensor bias errors will grow linearly with time and are often the dominant error source in an INS. These errors can be estimated and removed with an effective calibration.

**Sensor bias repeatability (turn-on):** Frequently when an INS is powered up, the bias observed in each sensor's outputs will be different from turn on to turn on. This can be due to changing physical properties in the INS, environmental conditions and internal signal processing in the INS. A very repeatable sensor output leads to quicker and better calibration of the sensor, whereas sensors with more variable biases required a much longer and often more complex calibration process.

**Sensor bias stability (in-run bias):** While an INS is powered up, the bias observed in each sensor's outputs can change over time. The change can be due to environmental conditions like temperature, pressure or mechanical stress on the sensors. For example, in the case of optical sensors, environmental conditions can change the optical path and thereby contribute to sensor bias stability. For this reason, calibration and internal sensor monitoring generally include corrections for environmental conditions, such as temperature.

**Scale factor:** Whereas biases are constant offsets in a sensor's output, scale factor errors represent a linear error that is a function of the sensor input. The error in the sensor's output is proportional to the magnitude of the sensor's inputs. The effects of scale factor errors are thus most prevalent in application involving high acceleration and angular motion.

**Random Walk:** When a sensor measures a constant signal, a random error is always present in each sensor output. Integration of the random errors in the measurements lead to a random walk error, which are zero mean, but cause the sensors to walk off randomly. Random walk is the largest error sources in many inertial sensors and can cause INS errors to grow unbounded.

**Misalignments (non-orthogonality):** In an INS, the three gyroscopes and three accelerometers are mounted orthogonal (at 90-degree angles) to one another. The sensor mountings have errors, however, so the axes are not perfectly at 90 degrees; thus, the axes are misaligned. This leads to an undesirable correlation between sensor outputs. For example, assume one axis is pointed perfectly vertical and the INS is level. The accelerometer on this axis is measuring gravity. If the other two axes were perfectly orthogonal, they do not measure any of the effect of gravity. If there is a misalignment so that the non-vertical accelerometers also measure components of gravity, then this leads to an error in the INS output due to axis misalignment.

**G and G-squared Dependencies:** Some accelerometers and gyroscopes are sensitive to changes in sensed acceleration. When the sensor experiences a change in ac-

celeration (G-dependency) along the sensitive axis, then the sensor bias changes, resulting in an output error in the system. G-squared dependencies are a result of non-linear effects of changes in acceleration on the sensor outputs. Sensors undergoing high rates of acceleration can be calibrated for these types of errors.

### 2017. Coordinate Systems

Two orthogonal coordinate systems are used to relate the inherent errors to the inertial navigator. One system is

the north-east-down system mentioned in Section 2013, consisting of orthogonal N, E, and D axes. The relationship of this coordinate system to the second system, the equatorial coordinate system, is shown in Figure 2017. The equatorial system consists of P (polar), Q (equatorial), and E (east) axes. The P axis is parallel to the earth's axis of rotation. The Q axis is parallel to the equatorial plane and is directed outward from the earth's axis of rotation. The E axis is coincident with the E axis of the other coordinate system.

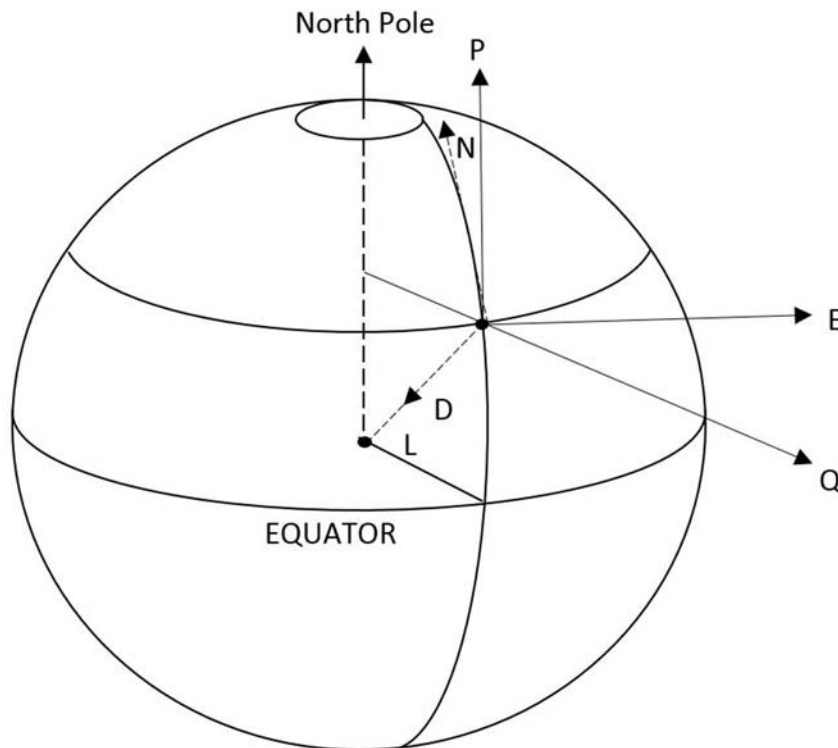

Figure 2017. Orthogonal coordinate systems.

The first coordinate system is physically represented in the gyroscope arrangement on the stable platform of the inertial navigator. The computer of the inertial navigator maintains a mathematical representation of the equatorial coordinate system. The relationship of the two systems is expressed mathematically as:

$$N = P \cos L - Q \sin L$$

$$E = E$$

$$D = -P \sin L - Q \cos L$$

In some of the following examples, the equatorial coordinate system is used to explain the origin of INS errors.

In these cases, the equatorial coordinate system allows for an easier visualization of the error source than any other coordinate system. However, the reader should remember that the principles of INS, including the observable errors, are independent of the mechanization or chosen reference frame for the platform alignment.

### 2018. Schuler Oscillation

Schuler tuning, described in Section 2013, is a computation made in the INS to ensure that the vertical indication of the inertial navigator remains correct as the craft moves over the curved surface of the earth. Figure 2018a shows a block diagram of the Schuler “loop,” which is the combination of the Schuler tuning described in Section 2013 (shown

in solid lines) and the inherent feedback of any residual platform tilt errors into the horizontal accelerometers (shown in dashed lines).

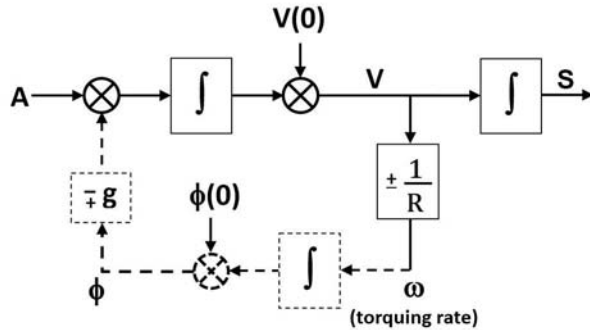

Figure 2018a. Block diagram of the Schuler loop.

For a local-vertical stabilized INS, when no platform tilt errors exist, no gravity acceleration is sensed by the horizontal accelerometers. The only quantity measured is the horizontal acceleration  $A$ , which is integrated to produce velocity  $V$ . This velocity is divided by the radius of the earth (positive for east-west motion, negative for north-south motion, as described in Section 2013) to produce the angular rate  $\omega$ . This angular rate offsets the actual angular rate at which the platform is tilting in the opposite direction. Therefore, when  $\omega$  is integrated again, the resultant angle fully offsets the platform tilt, yielding a residual platform tilt,  $\phi$ , of 0. Thus, no acceleration error due to gravity is sensed, and the platform maintains its correct vertical indication.

However, if a platform tilt should arise in error, the horizontal accelerometer will sense a gravity component and interpret this as a true acceleration. When integrated over time, a velocity error,  $\delta V$ , will result, leading to a calculated angular rate  $\omega$  that does not match the actual angular rate of motion over the earth. The residual platform tilt,  $\phi$ , will be non-zero, and a component of gravity will continue to be felt by the horizontal accelerometer.

Mathematically, the horizontal acceleration error is given by:

$$\delta A = \mp g \sin(\phi) \approx \mp g \phi$$

The small angle approximation is used to simplify the error term. The positive or negative sign is determined by the assumed direction of motion over the earth: A translation of gravity from the down direction to the north direction causes a positive rotation around east, while a translation from the down direction to the east direction causes a negative rotation around north.

Integration of an acceleration error results in a velocity error:

$$\delta V = \int \delta A dt = \mp g \int \phi dt$$

The error in velocity leads to an error in the angular rate calculation:

$$\delta \omega = \pm \frac{\delta V}{R} = -\frac{g}{R} \int \phi dt$$

By definition, the angular rate is equal to the first derivative of the angle  $\phi$ ; thus,

$$\delta \omega = \frac{d\phi}{dt} = -\frac{g}{R} \int \phi dt$$

Differentiating:

$$\frac{d^2 \phi}{dt^2} = -\frac{g}{R} \phi$$

The solution to this equation is an oscillation:

$$\phi = \phi_0 \cos\left(\sqrt{\frac{g}{R}} t\right)$$

where the initial platform tilt  $\phi_0$  determines the amplitude of the oscillation and the oscillation frequency is given by  $\sqrt{g/R} \approx 84.4$  minutes. This equation is the same as that of a simple pendulum with a length equal to the radius of the earth. The initial tilt error gets integrated into both velocity and position, causing the characteristic Schuler error in those outputs.

To visualize what is being sensed by the INS, one can consider an INS platform that is stationary, but has an initial tilt error  $\phi$ , as shown in Figure 2018b. The initial tilt causes the platform computer to think it is located to the right of its actual position, and a portion of the downward gravity vector will be sensed in the right side of the platform, causing the computer to think the platform is accelerating to the left. The computer's interpretation is shown at position  $A$  in Figure 2018c.

As the computer thinks the platform is moving to the left toward position  $B$  (its true position), the Schuler tuning will incrementally reduce the tilt error until the platform is level at position  $B$ . At this point, the horizontal accelerometer no longer senses gravity, so the acceleration and tilt errors are both zero. However, the erroneous accelerations computed until now lead the platform to believe velocity is now at a maximum and that the platform is still moving to the left. The Schuler tuning will continue to mathematically or physically torque the platform counterclockwise to compensate for this assumed motion over the earth, until the computed velocity is reduced to zero at position  $C$  in Figure 2018c. At this point the computed acceleration is equal and opposite to the computed acceleration at  $A$ , and the process begins again, but in the opposite direction.

Figure 2018d, Figure 2018e, and Figure 2018f show the graphical representation of the tilt, acceleration, velocity, and position errors at the various points

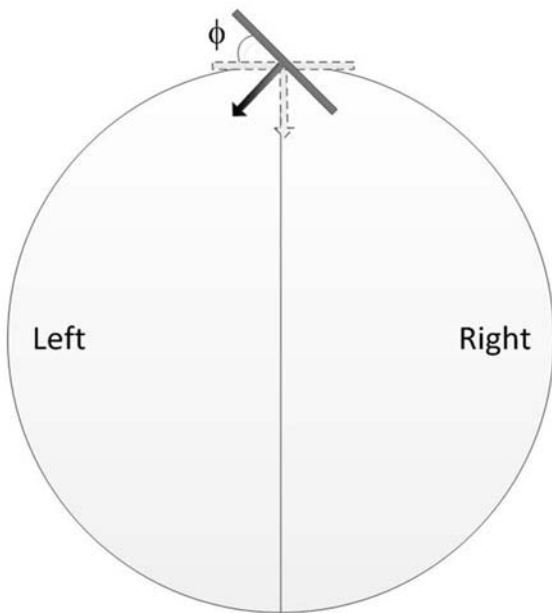

Figure 2018b. Stationary platform with initial tilt error  $\phi$ .

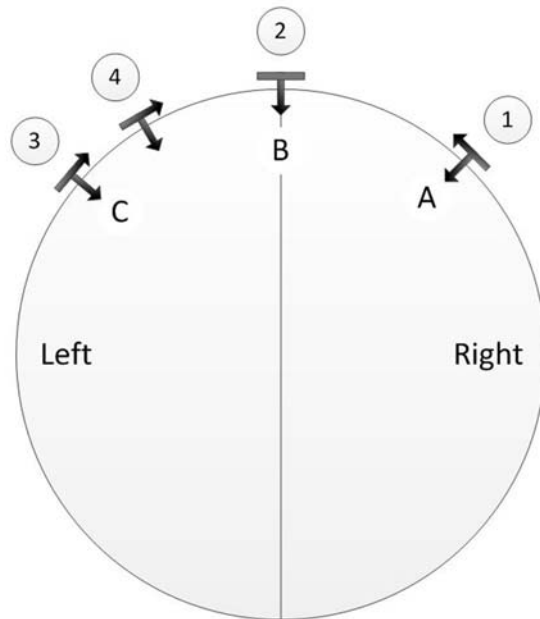

Figure 2018c. Platform computer's interpretation of position and velocity.

displayed in Figure 2018c. In Figure 2018d, the size of Area A represents the total velocity that is computed from the time the platform is assumed to be at position A until the platform is level again at assumed position B. At this point the velocity error is at a maximum (Figure 2018e), and position error is zero (Figure 2018f). The sum of Areas A and B yield the total velocity computed by the time the platform has reached assumed position C. Because one of these areas is positive and one is negative, they cancel, yielding zero velocity. Figure 2018e and Figure 2018f show a zero velocity error and a maximum position error, respectively. Area C shows an

incremental velocity that is computed between points 3 and 4 in Figure 2018c.

Remember that in this example, the platform is not actually changing its position during this process. It is stationary at position B, with tilting back and forth as the only physical movement. These errors will repeat in a regular oscillation until the system is affected by an outside force that either intensifies the magnitude of tilt, velocity, and position errors, or reduces it. Provisions must be made for damping (Section 2024) this oscillation.

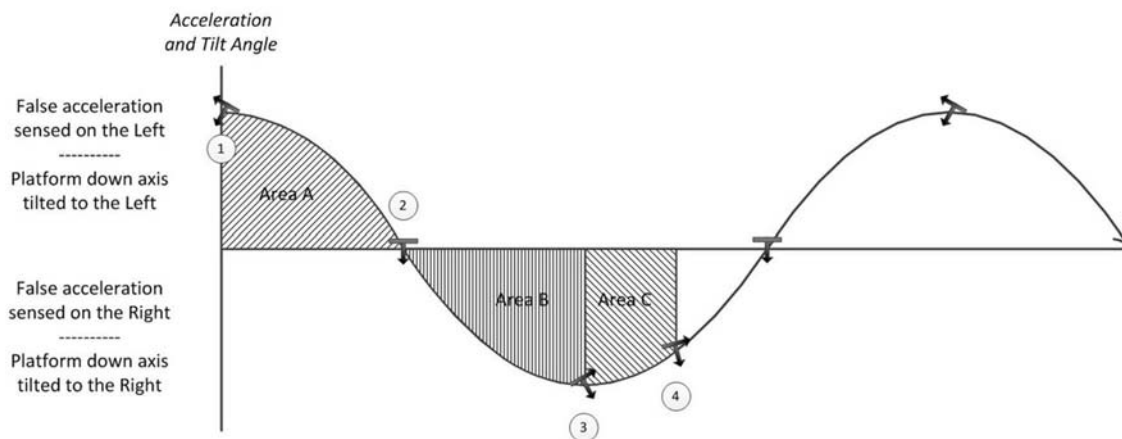

Figure 2018d. Graphical representation of Schuler acceleration and tilt error.

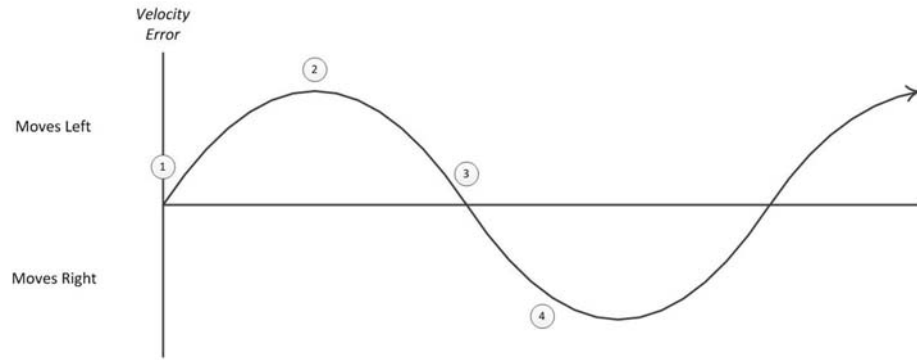

Figure 2018e. Graphical representation of Schuler velocity error.

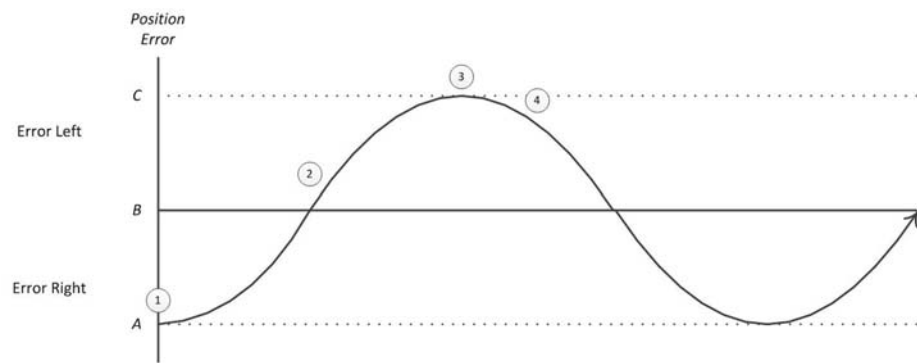

Figure 2018f. Graphical representation of Schuler position error.

**2019. Earth Loop Oscillation**

The 24-hour earth loop oscillation is caused by initial errors in platform alignment or gyro bias. An initial error in either latitude or heading causes both quantities to oscillate about their true values within a 24-hour period. A gyro bias error limits the ability of the inertial navigator to determine latitude and heading, thus causing latitude or heading to oscillate about an offset value. The following discussion illustrates the 24-hour oscillation for an initial heading error.

In Figure 2019a, the inertial navigator is stationary on the equator at point  $T_0$ , with a platform misalignment such that there is a displacement of the equatorial coordinate system (Section 2017) sensed by the navigator (designated by  $P'$ ,  $Q'$ , and  $E'$  in the figures) from the true equatorial coordinate system (designated by  $P$ ,  $Q$ , and  $E$  in the figures). Thus, as the earth rotates around the  $P$  axis, the navigator senses that it is rotating around the  $P'$  axis. In inertial space, the navigator senses that it is following the dashed path in Figure 2019a rather than the solid equatorial path.

The platform misalignment is initially a heading error—that is, a displacement about the  $Q$  axis—and is represented by the angle  $\delta_Q$  between  $E$  and  $E'$ . As shown, this is a positive heading error because the heading readout of the

navigator will be larger than the actual heading by the amount  $\delta_Q$ . No latitude or longitude error results because there is no displacement about either the  $E$  or the  $P$  axis (i.e., the  $Q$  axis and  $Q'$  axes are coincident).

After this initial setup, the earth rotates about the  $P$  axis and the navigator mathematically rotates about the  $P'$  axis. Recall that while the  $P$  and  $P'$  axes maintain their positions in inertial space, the  $E$  and  $Q$  axes (and the  $E'$  and  $Q'$  axes) are always oriented relative to the navigator. After 6 hours the navigator is at point  $T_6$  due to earth's rotation, and the relationship between the coordinate systems has changed (Figure 2019a (B)). The misalignment between the two systems is now about the  $E$  axis and is shown as the angle  $\delta_E$ . This represents a negative latitude error in the navigator since its coordinates are displaced in a negative rotation about the  $E$  axis, and the heading error is now zero, because there is no displacement about the  $Q$  axis (i.e.,  $E$  and  $E'$  axes are coincident with each other). Hence after 6 hours the heading error has been reduced to zero, but a negative latitude error has been produced.

The earth continues to rotate, and after 6 more hours, the navigator is at the position  $T_{12}$ , shown in Figure 2019a (C). Once again the misalignment of the navigator's reference system with respect to the earth is about  $Q$  axis, meaning an error in heading and no error in latitude. This

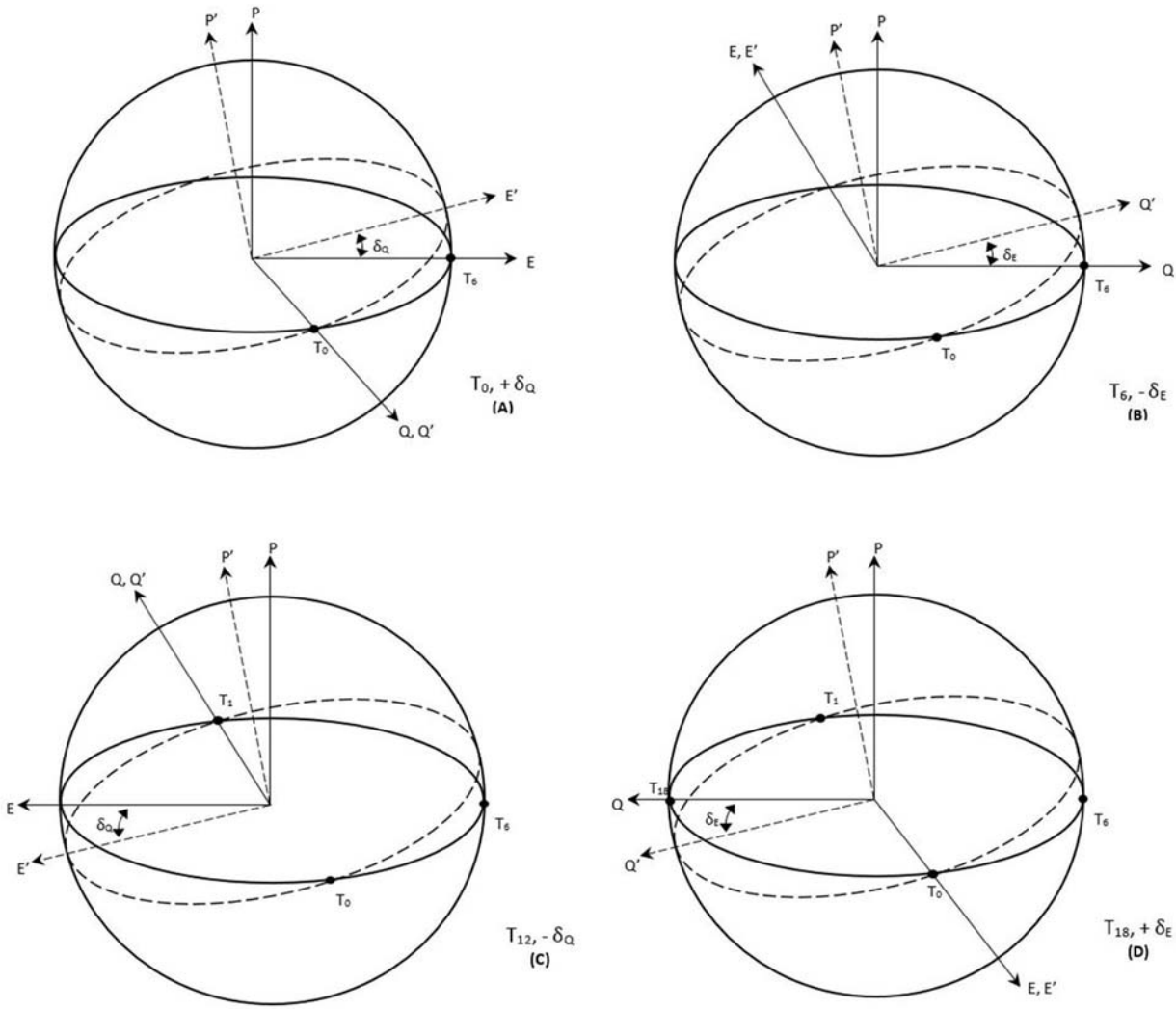

Figure 2019a. The 24-hour oscillation for an initial heading error.

time the heading error is negative but of the same magnitude as at  $T_0$ .

During the next 6 hours this negative heading error diminishes until it has decreased to zero as shown in Figure 2019a (D). At the same time, the latitude error is building up in a positive direction to the value shown. At  $T_{18}$  the misalignment of the navigator is about the  $E$  axis again, which results in a positive latitude error and no heading error. This positive latitude error has a magnitude equal to the negative latitude error at  $T_6$ .

If the errors shown in Figure 2019a are plotted against time, the latitude error will be a negative sine wave with a 24-hour period since the oscillation started with a positive heading error. The heading error will be a cosine wave with a 24-hour period. The latitude error curve leads the heading error curve by a  $90^\circ$  phase relationship. At the equator, due to the geometry of the reference systems, the maximum value of  $\delta_Q$  equals the maximum value of  $\delta_E$ . At the equator

the maximum latitude and heading errors due to the 24-hour oscillation are equal.

The relationship among navigator errors is a function of latitude. Figure 2019b represents an initial heading error as a vector along the local vertical. This vector represents a displacement of the navigator's reference system about this axis and is a positive heading error in this example. The components of this misalignment along the  $P$  axis and the  $Q$  axis are also shown. The component along the  $P$  axis is equal to  $\delta_H \sin L$  and contributes to the longitude error of the navigator since it is a misalignment about the earth's spin axis or polar axis. This relationship shows that at the equator, the heading error would cause no longitude error and there would be no 24-hour oscillation in longitude. The other component along the  $Q$  axis is called  $\delta_Q$  and has a value of  $\delta_H \cos L$ . This component determines the 24-hour oscillation due to an initial heading error in an inertial navigator with no uncompensated gyro drifts.



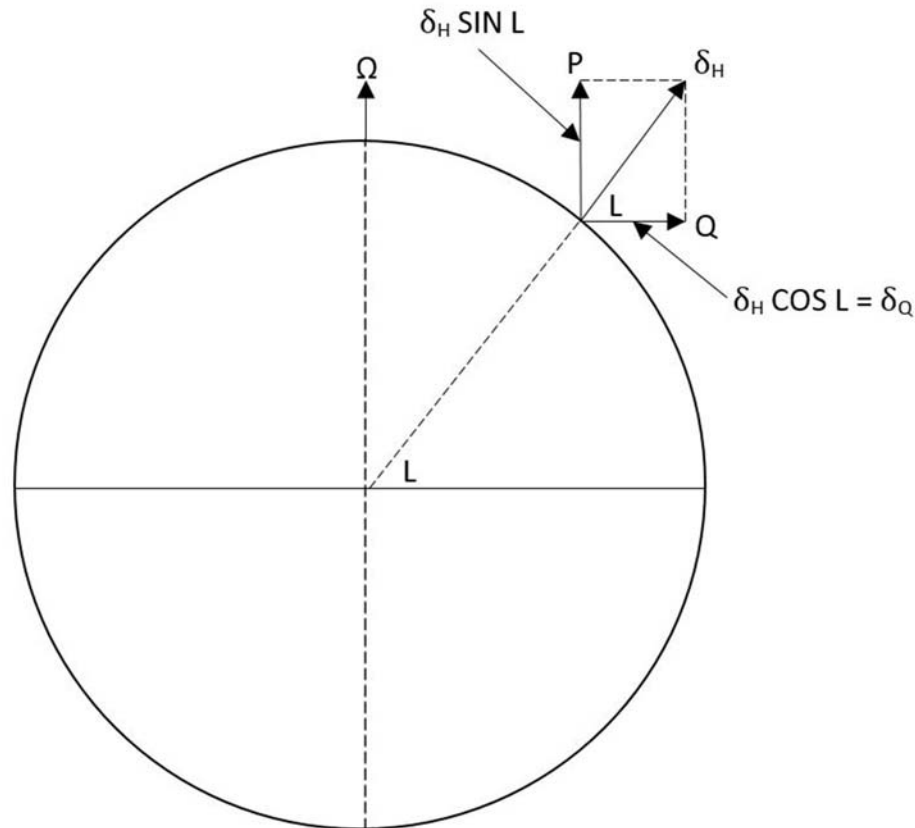

Figure 2019b. Relationship among misalignment errors of inertial navigator.

In the 24-hour oscillation, the maximum  $\delta_Q$  occurs 6 hours after the maximum  $\delta_E$  and the two have equal magnitude. The heading error ( $\delta_H$ ) is in phase with  $\delta_Q$ , but  $\delta_H = \delta_Q \sec L$ . Therefore, the 24-hour oscillation when present appears in the latitude, heading, and longitude outputs of the inertial navigator with the following relationships as shown in Figure 2019c.

1. The latitude error equals  $\delta_E$ .
2. The heading error equals  $\delta_Q \sec L$ .
3. The longitude error equals  $\delta_H \sin L$  or  $\delta_Q \tan L$ .
4. Latitude, heading, and longitude errors oscillate as a sine wave with a 24-hour period.
5. The latitude error leads the heading error by 6 hours or  $90^\circ$ .
6. The heading error and longitude error oscillations are in phase.
7. The maximum heading error equals the maximum latitude error multiplied by the secant of the latitude position.
8. The maximum longitude error equals the maximum latitude error multiplied by the tangent of the latitude position.

Since heading error is a function of latitude, the usual practice is to use a normalized heading value for the plotting of this error. This is accomplished by multiplying the heading error by the cosine of the latitude position. This results in a plot of  $\delta_Q$ . The  $\delta_Q$  curve is equal in amplitude to the  $\delta_L$  curve.

## 2020. Position Offsets

Position offset errors cause the INS to operate about a non-zero mean error value in position or heading. They can be introduced into the system by operating in areas with significant vertical deflection (Section 2014), in which case the value of the induced bias will be equal to the angular offset of gravity from the vertical at that point. They can also be caused by uncompensated gyro drifts. The example below shows how an uncompensated gyro drift can cause a position offset. In this example, it is assumed that the system is "settled," meaning there is no earth loop oscillation present in the INS output.

A gyro drift is an internal disturbance which causes an output signal from the gyroscope. In gimballed systems, the stabilization loop interprets it as a disturbance of the stable element's orientation and drives the gimbals accordingly. This causes a misorientation of the stable element and results in inertial navigator errors. Although the drift cannot

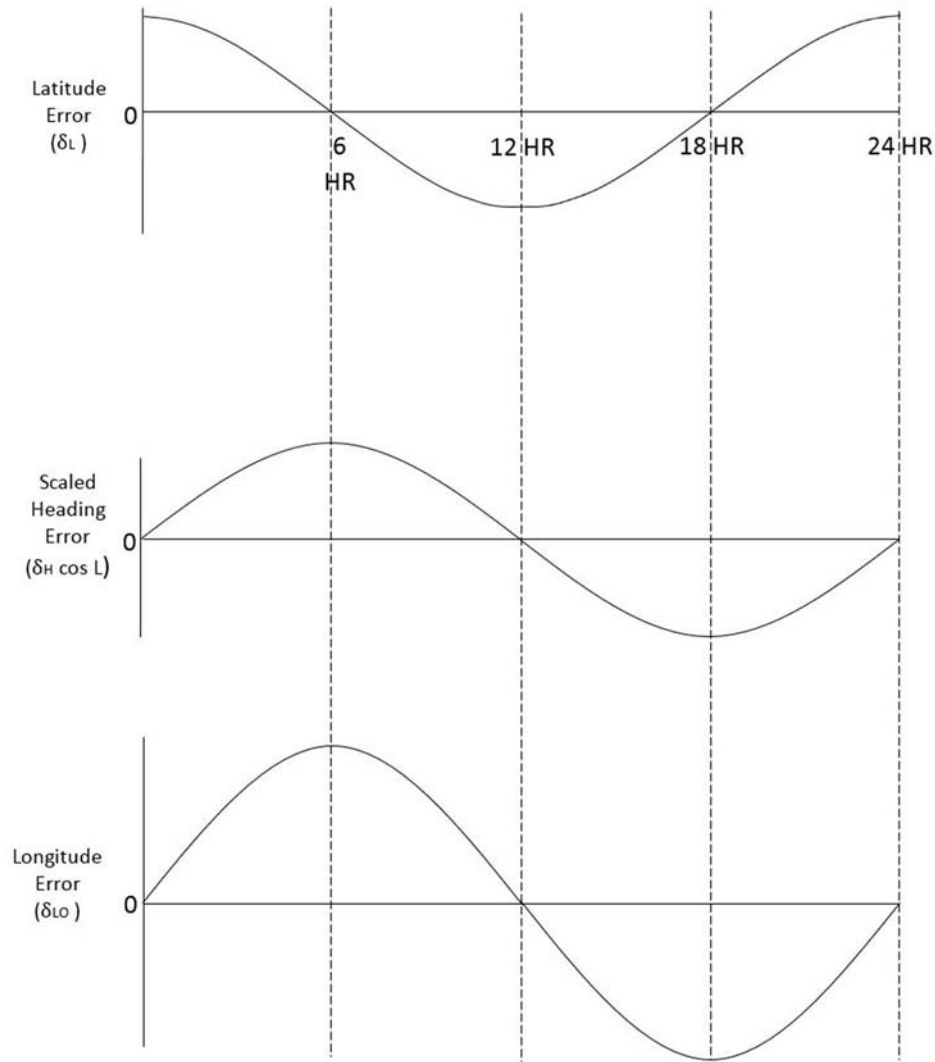

Figure 2019c. Inertial navigator 24-hour oscillation error plots.

be completely removed, it is possible to compensate for it by applying a gyro torquing signal called a bias. If the bias is proper, there is no gyroscope output due to drift. If the gyro bias is not correct or whenever the drift of a gyroscope changes and a new bias is needed, then there is a gyro bias error or a gyroscope with uncompensated drift. Strapdown sensors perform the equivalent functions described above algorithmically rather than mechanically.

Although the gyroscopes are placed physically in the inertial navigator's coordinate system ( $X, Y, Z$ ), the effect of gyro bias errors is better described in terms of the equatorial coordinate system ( $P, Q, E$ ). Using hypothetical gyroscopes in this coordinate system makes the analysis simpler. When completed, the results can be transferred into the physical gyroscope coordinates by using the relationships given in Section 2017. The  $X, Y$ , and  $Z$  gyroscopes have  $P, Q$ , and  $E$  uncompensated drift rate components ( $\delta_{BP}, \delta_{BQ}$  and  $\delta_{BE}$ ).

Considering that the inertial navigator is a model of the earth and assuming that there is no movement with respect

to the earth of the craft in which the navigator is installed, then the only motion of the navigator in space is about its polar axis at earth rate. However, if the equatorial gyroscope has a bias error,  $\delta_{BQ}$ , then there is an additional rotation about this axis in space. The navigator will then rotate in space about the vector sum of these two rotations. This causes the instrumented polar axis of the navigator indicated as  $P''$  to be displaced about the east axis as shown at  $A$  in Figure 2020a.

Figure 2020a shows that the reference coordinates of the inertial navigator are aligned with the earth's coordinates. This means that earth rate torquing in the navigator ( $\Omega_T$ ) is applied about an axis parallel to the earth's spin axis. However, the navigator is rotating at earth rate (shown by  $\Omega_S, S$  for actual rotation of navigator) about  $P''$  due to  $\delta_{BQ}$ . If left this way the equatorial gyro bias error would cause a 24-hour oscillation. To achieve a settled system with the equatorial gyro bias error,  $\delta_{BQ}$ , the instrumented

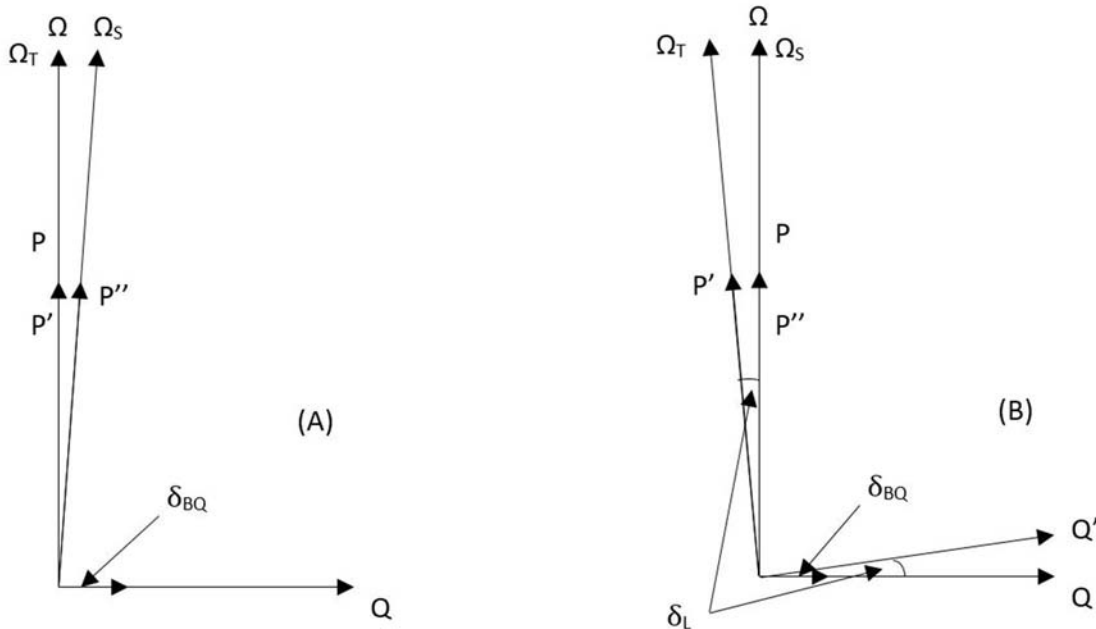

Figure 2020a. Effects of equatorial gyro bias error.

polar axis,  $P''$ , must be made to coincide with the earth's spin axis. This is accomplished by a latitude error or  $\delta_L$  as shown at  $B$  in Figure 2020a. The amount of latitude error needed to settle the system is related to the equatorial gyro bias error by the following relationship:

$$\delta_E = \delta_L = \frac{\delta_{BQ}}{\Omega}$$

View  $B$  of Figure 2020a shows the earth rate torquing ( $\Omega_T$ ) of the navigator being applied about the displaced  $P'$  axis. However, the  $\delta_{BQ}$  about the displaced  $Q$  axis ( $Q'$ ) causes the navigator to rotate at earth rate ( $\Omega_S$ ) about the  $P''$  axis which is now aligned to the earth's spin axis ( $P$ ). If there is an equatorial gyro bias error present but the navigator is not settled, then the 24-hour oscillation occurs not about zero error but about a latitude error given in the above relationship. As a result an equatorial gyro bias error results in an offset or constant error in latitude which may or may not have a 24-hour oscillation superimposed upon it. The equatorial gyro bias error defines the settling point for latitude.

In the case of an east gyro bias error,  $\delta_{BE}$ , the instrumented polar axis would be displaced about the equatorial axis. Again, to settle the navigator with an east gyro bias error, the instrumented polar axis must be made coincident with the earth's spin axis. To do this the navigator coordinates must be misaligned about the equatorial axis an amount given by:

$$\delta_Q = \delta_H \cos L = \frac{\delta_{BE}}{\Omega}$$

If the displacement about the equatorial axis is the above amount, the navigator would be settled. The  $\delta_Q$  results in a heading error which varies as a function of latitude as discussed with respect to the 24-hour oscillation. If the navigator is not settled and has an east gyro bias error, the 24-hour oscillation in heading will be about an offset error defined by the above equation. If heading error times the cosine of latitude is plotted for a given east gyro bias error, this offset is constant and is a function of the magnitude of the gyro bias error.

If there is both an equatorial and east gyro bias error, there is a settling point for the navigator involving both a latitude error and a heading error. Figure 2020b illustrates the error propagation in an inertial navigator which had no errors previous to time 0 and then at time zero a bias error occurs in each of the gyros. View  $A$  shows that the latitude error oscillates about a value determined by the equatorial gyro bias error (the stand-off error in latitude due to an equatorial gyro bias error). The heading error as seen at view  $B$  oscillates about the stand-off error due to the east gyro bias error. The phase relationship is as discussed earlier and the magnitude of the 24-hour oscillation errors is a function of the initial conditions of the navigator.

### 2021. Longitude Ramps

Longitude ramps are another error feature that can be caused by a gyro bias error, this time in the polar gyro.

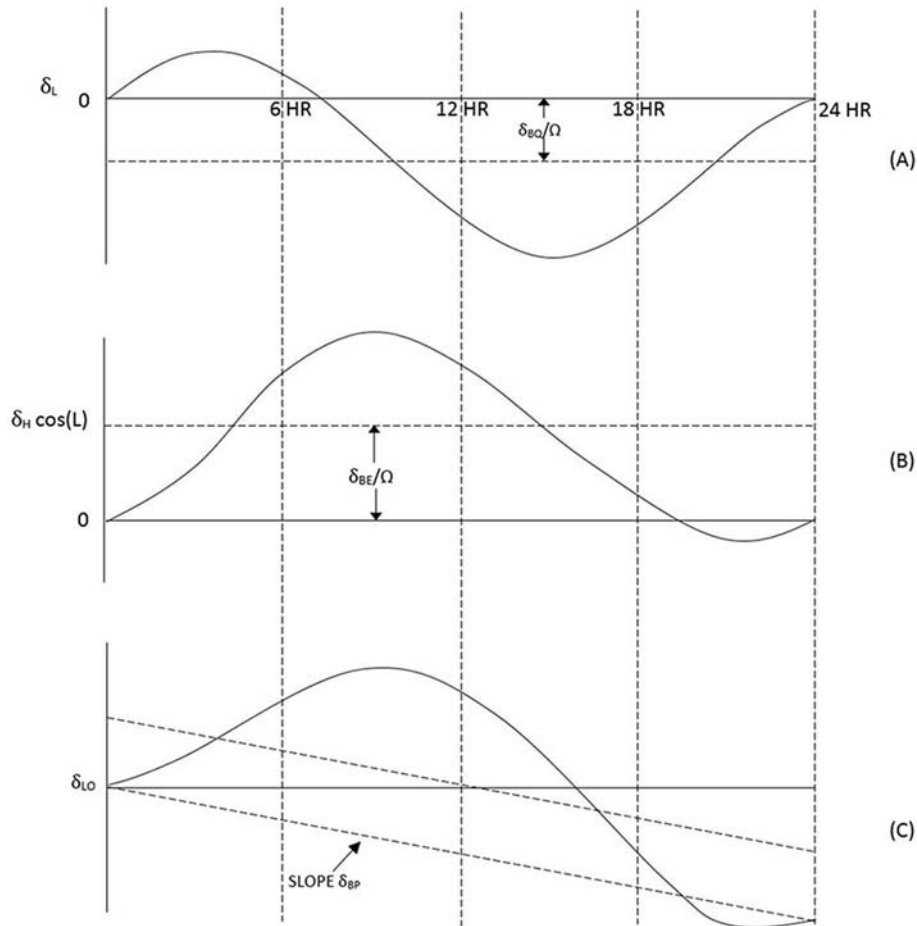

Figure 2020b. Inertial navigator error plots.

Since this bias error occurs about the earth's spin axis, it doesn't change the orientation of the inertial navigator's instrumented polar axis. Instead the polar gyro bias error causes the navigator to rotate about the polar axis at a rate different from the earth's rotation. The navigator interprets this as change of position on the earth about the polar axis which is longitude change or longitude rate. The bias error has a constant value, resulting in a constant longitude rate error. The longitude rate is integrated with time in the navigator to produce an increasing longitude value. As a result

the polar gyro bias error contributes a straight line function to the longitude error. The slope of this line equals the polar gyro bias error or longitude ramp.

View C of Figure 2020b shows the longitude error at latitude  $45^\circ\text{N}$ . The longitude error starts at zero in this case because of the initial conditions previously set up. The longitude error oscillates relative to the polar gyro bias error in the same phase as the heading error oscillates about the latitude gyro bias error.

## CONTROLLING INERTIAL NAVIGATION SYSTEM ERRORS

### 2022. Controlling Inertial Navigation System Errors

Every INS will output navigation parameters (position, velocity attitude) with errors; thus, provisions and mechanisms are included to reduce or bound errors. Prudent navigators will understand the limitations of their INS, the inherent errors expected, and the options available to optimize INS performance and the methods to reduce or bound INS errors. INS errors are controlled by calibration of the inertial sensors, and the use of various navigation aids for

damping and resetting the inertial sensors. The following sections describe the methods or compensations for common error sources.

Integration of these navigation aids with an inertial navigator can take many forms; however, many modern systems make use of Kalman Filtering (Figure 2022) to control INS errors. The subject of Kalman Filtering is beyond the scope of this section. However, at its basic level, a Kalman Filter models the inertial navigation system as a linear system of states, where each state represents position,

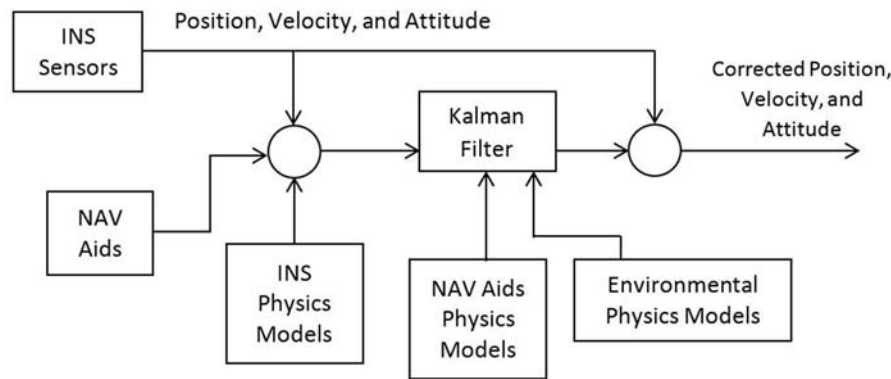

Figure 2022. Block diagram of Kalman Filter inputs.

velocity, attitude, gyroscope, and accelerometer errors. The Kalman Filter also models the measurement errors of the navigation aiding sensors and any environmental errors that affect the inertial navigation system. The Kalman Filter estimates the inertial navigation system errors. These estimates are then used to correct and control the error and error growth of the inertial navigation system.

### 2023. Calibration

Errors in an inertial navigation system's accelerometers and gyroscopes will significantly impact the system's navigation performance. An INS that is considered *free inertial* is a system in which these errors are allowed to integrate into the velocity and position unbounded. Typically, however, inertial navigators employ methods to calibrate, estimate, and control these sensor errors.

For platforms that use gimbals, the calibration can take the form of inducing motions into the platform to make the inertial sensor errors observable. This typically is conducted upon system startup and includes inducing known rotations or known orientations of the platform and measuring the inertial sensor outputs. Since the inputs to the inertial sensors are known to a reasonable level, the difference between the reported output of the sensor and the true known input from the sensor provides an estimate of the sensor error. Calibration provides estimates of sensor biases, misalignments, scale factors and noise parameters that are then used to interpret the signals from the inertial sensors. There are a variety of techniques which are employed depending on the exact nature of the sensor errors, the intended application, and the capabilities of the gimballed system.

For strapdown systems, initialization will likely include both stationary operations, and specified ship motion calibrations that require large angle turns or course reversals, along with continuous GPS or other fix sources. Strapdown INSs are much more dependent on inputs from accurate external fix and damping sources to maintain navigation accuracy than are gimballed systems.

### 2024. Damping

Damping refers to the process of reducing the amplitude of an oscillation. In an INS, damping is used to control the Schuler errors. In order to reduce the amplitude of the oscillation, the sensed velocity caused by the gravity acceleration must be separated from the actual velocity of the craft. The error can then be subtracted from the accelerometer signal, leaving a signal that reflects the true craft motion.

To distinguish between the actual craft velocity and the oscillating velocity error, a secondary source of craft velocity must be used. The secondary source must be unrelated to the accelerometers and unaffected by gravity, such as GPS or a water speed log. By subtracting this secondary reference velocity from the accelerometer-derived velocity output, the actual craft velocity is canceled out, leaving only the error. This error component, then, can be subtracted from the accelerometer output.

Figure 2024a is an example of a simple third-order damping loop. The accelerometer output,  $A$ , is integrated into a velocity,  $V$ , from which the reference velocity,  $V_R$ , is subtracted. This subtraction yields the difference between the two signals,  $\Delta V$ . The difference is multiplied by the damping coefficient,  $C1$ , which specifies how much of the signal to feed back to the accelerometer output.

If the reference velocity includes a constant error in speed over ground, such as might occur when using a water speed sensor in a constant current, then  $\Delta V$  will also contain that error. If this reference velocity error is fed back to the accelerometer output, it will lead to a bias in the INS-derived positions and velocities. Thus, it is desirable to remove any constant bias from the damping signal before applying it to the accelerometer output. This is accomplished by sending the signal through a second integrator and subtracting a portion (determined by the damping coefficient  $C2$ ) from the original damping signal. The resulting signal is subtracted from the accelerometer output.

Another damping technique is to use a Kalman filter to

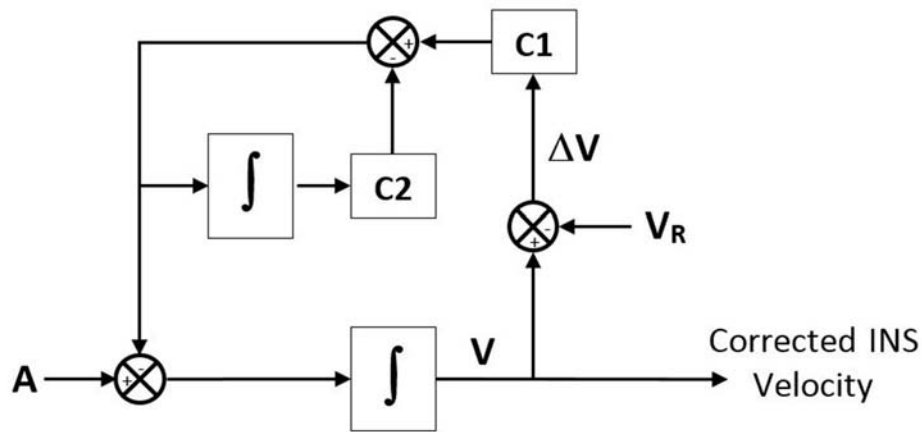

Figure 2024a. Third-order damping loop.

perform velocity and associated position and alignment state “resets” based on the difference between inertial and reference velocity. This technique is usually known as Kalman (or discrete) damping. Similar to third-order damping, Kalman damping can also account for constant differences between inertial and reference velocity. Additionally, Kalman damping uses an error model to attempt to estimate system errors better. Since a Schuler-tuned system oscillates with an (approximate) 84-minute period whenever it is disturbed, a filter can be designed based on this fact to correct velocity and tilt errors caused by Schuler errors very rapidly.

While both third-order and Kalman damping are designed to handle constant biases in the reference velocity, unexpected or unmodeled changes in either the inertial or reference velocities will still cause errors to develop in the system. Thus, it is advisable to operate the system “undamped” when the reference velocity is known to be disturbed, such as when using a water speed log in a changing current or in any case the reference velocity output is suspect. In addition, when operating in areas of uncompensated VD, any form of damping that adjusts the underlying system error model (such as Kalman damping) should be avoided. Third-order damping is appropriate when in high-VD areas.

While the horizontal Schuler errors in INSs are oscillatory, gravity-induced vertical errors in an INS output are inherently unstable (small errors in vertical velocity lead to *increasing* errors, rather than oscillatory errors). Thus, the vertical velocity channel requires essentially continuous damping in order to maintain reasonable outputs. For a vessel on the surface of the ocean, vertical velocity can be damped to a reference of 0. For submarines, vertical reference velocity can be provided by a depth detector, whereas aircraft may use a barometer to provide this input.

## 2025. Reset

A reset, or fix-reset, is the mathematical process in an INS in which external position information, such as from GPS, is compared with the INS output and the resulting difference is used to estimate the INS sensor errors remaining in the system. A fix-reset can be thought of as a mini-calibration of the INS. A Kalman filter, modeling the major errors, is used to process the position fix information to re-estimate the known errors (such as gyro bias and drifts) to improve the future estimate of the navigation parameters. At the same time, a correction is applied to the inertial navigator's current position output. The process of entering these corrections into the navigator for this purpose is called a **reset**.

The effect of a reset is threefold: it will immediately reduce the INS errors in position, velocity and attitude; it will improve long term estimation of future errors and thus reduce navigation errors until the next fix-reset; and it will reduce its own internal estimate of uncertainty which will impact the weight applied to future fix-resets (a function of time and fix quality, as well as the internal estimate of the historical error growth).

Position resets are most effective when they are inserted at the peak of the earth loop errors; however, even without knowing when these errors are at a maximum, resets can be effective if timed correctly. Resets should be spaced such that different magnitudes of error on the unknown oscillation will be adjusted each time. Earth loop oscillations reach their maximums-and likewise, minimums-in 12-hour intervals, meaning that 12 hours from now, the error will be of the same magnitude as it is now. Thus, resetting at 12-hour intervals (or multiples thereof) is discouraged, because if the magnitude of the error is small at that point, then repeatedly resetting the same small error will have little long-term effect on navigator performance. Rather, reset intervals of 12 + 2 hours would guarantee that some of the time, resets would be inserted when the error is

large. Figure 2025 illustrates the variation in position error observed at 10-hour intervals, compared to the error at 12-hour intervals. In addition, navigators should ensure that large Schuler errors are not apparent, and that the vessel is not in an area of very high vertical deflection at the time of the reset.

Platforms with continuous access to GPS often reset their inertial navigation systems continuously. The advantage is that the INS remains aligned to GPS and the accelerometers and gyroscopes can achieve additional calibration and performance grooming. The disadvantage is

that the navigator is unaware of the true performance of their INS when GPS is lost, and may result in a false sense of security in the INS.

The navigator should remember that while the fix-reset process will initially eliminate or reduce errors, the errors will commence growing again following the reset. The rate of error growth will be based on the quality and frequency of the resets. The longer the time from a fix-reset, the greater the uncertainty of the output solution based on the inherent qualities of the sensors.

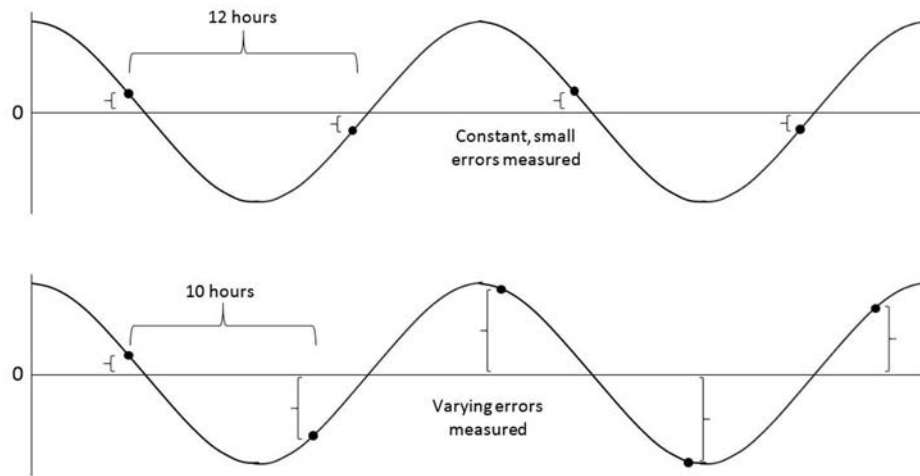

Figure 2025. Variation in error magnitude over different timing intervals.

## 2026. References

Britting, K. R., (1971). *Inertial Navigation Systems Analysis*. New York: John Wiley & Sons, Inc.,

Lawrence, A., (1993). *Modern Inertial Technology*.

New York: Springer-Verlag New York, Inc.

Titterton, D. H. and Weston, J. L. (1997). *Strapdown inertial navigation technology*. London: Peter Peregrinus, Ltd.